



C M G S O L U T I O N

IMPRESSÃO 3D

APRESENTAÇÃO



- 1 Redução no custo de produção;
- 2 Rápida fabricação do molde;
- 3 Maior liberdade para o seu projeto;
- 4 Prototipagem com alto nível de detalhamento;
- 5 Diversidade de materiais para impressão.

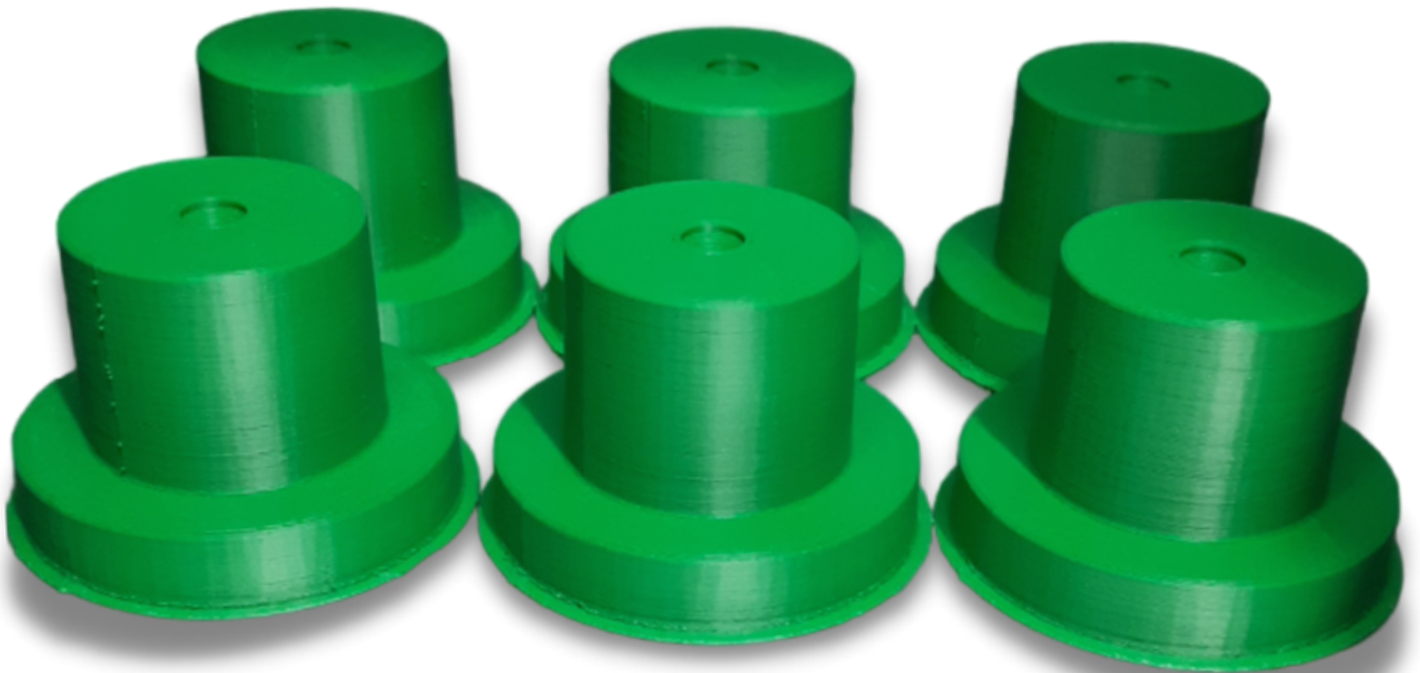

PROCESSO



1) ENVIO DA AMOSTRA

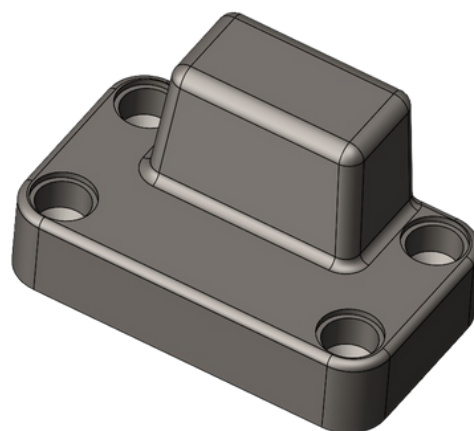

2) ELABORAÇÃO DO PROJETO

3) IMPRESSÃO DA PEÇA

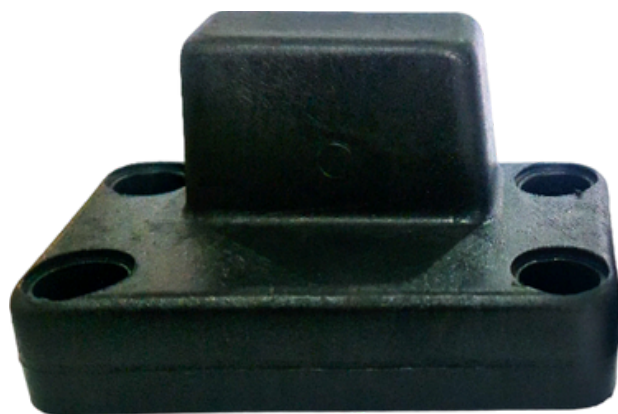
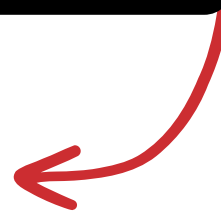

ANTIGA

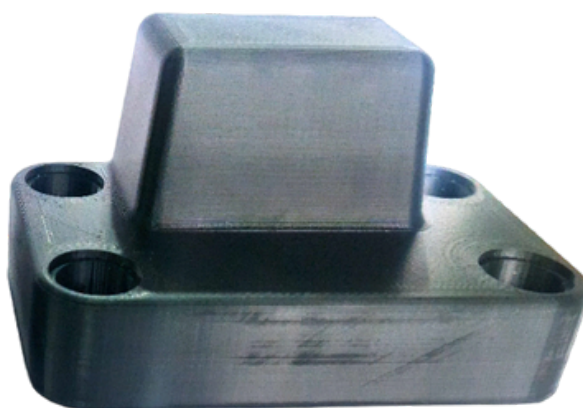

NOVA

*** CASO JÁ TENHA O PROJETO DA PEÇA, PULAR ETAPAS 1 E 2.**

ALGUMAS PEÇAS PRODUZIDAS POR NÓS:

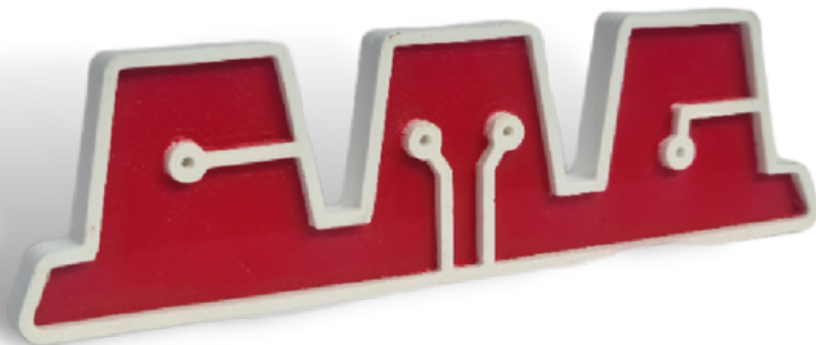
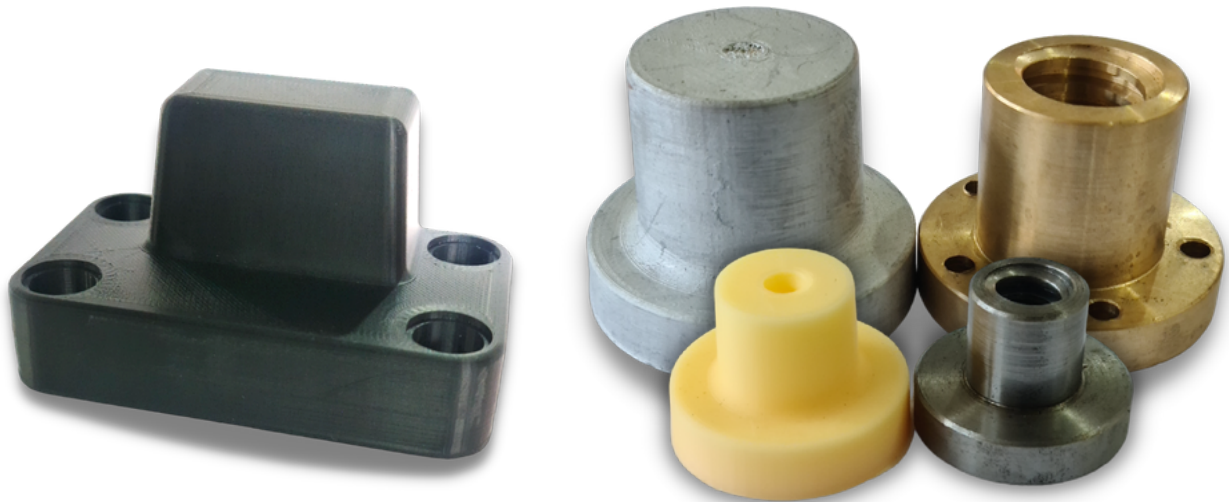



ENTRE EM CONTATO:



19 97416-0043



19 3513-8936



cmg@cmgsolution.com.br

